

Account Information

Date Account Number

Bill To

Phone Number Fax Number

Email Address Buyer

P.O. Number Patient Name

Ship To

Name

Address

City State/Zip Code

Phone Number

Please complete this form and return to Nutec Rehab by email - customerservice@nutecseating.com or fax to 833-722-0013.

Order Quote Only

Notes:

Nutec Rehab Inc.

Custom Seating

Order Form and Price List

Effective Date 1-22-2024



HCPCS Code: E2609 & E2617

Seating Specifications

Insert Dimensions

- A _____ Back Width
 - B _____ Lateral Width (Chest Width)
 - C _____ Hip Width
 - D _____ Seat Width
 - E _____ Back Height
 - F _____ Lateral Height
 - G _____ Seat Depth
 - H _____ Total Seat Depth
- (Add 1" - 3" to G for growth)

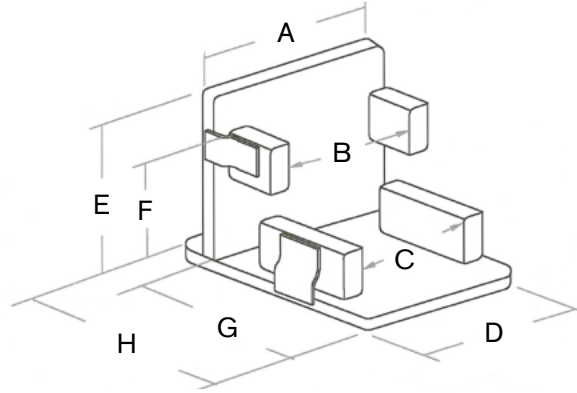

Seating Upholstery

Upholstery Color Options

(choose Seating System Upholstery)

Contact Surface color _____

Accent Fabric color _____

Lettering Block Script

Embroidered Name _____ Thread color _____

Contact Surface Fabrics

194 – Black Dartex
 194R – Reversed Black Dartex
 195 – Black Darlexx
 198 Black Lycra
 023 Air Flow
 201 – Black Neoprene

Accent Vinyl Fabrics

169 – Red
 227 – Raspberry
 223 – Light Pink
 293 – Laser Pink
 390 – Bright Yellow
 135 – Forest Green
 167 – Teal
 226 – Marina Blue
 225 – Grape
 224 – Dark Purple
 158 – Black
 151 – Carbon
 154 – Light Gray
 162 – Dark Gray
 391 – Orange

250- Sparkle Black Opal
 251 - Sparkle Apple Green
 252 - Sparkle Pink
 253- Sparkle Red
 254 -Sparkle Silver
 255-Sparkle Blue
 256-SparkleCharcoal
 257 - Sparkle Blue Green
 258- Sparkle Purple
 259 - Sparkle Green
 260- Sparkle Fuchsia

*See fabric swatch for additional upholstery options

Wheelchair Description

Model _____	Tubing Shape	Round	Square	Rectangular
Seat Width _____	Tubing Diameters			
Seat Depth _____	Seat	3/4"	7/8"	1" Other _____
Back Height _____	Top of Back	3/4"	7/8"	1" Other _____
	Bottom of Back	7/8"	1"	1 1/8" Other _____

Client Measurements in inches

- HH – Head Height _____
- SH – Shoulder Height _____
- USD – User Seat Depth _____
- LL – Leg Length _____
- CD – Chest Depth _____
- CW – Chest Width _____
- HW – Hip Width _____
- AH – Axilla Height _____
- EH – Elbow Height _____
- SW – Shoulder Width _____
- HDW – Head Width _____
- HC – Head Circumference _____

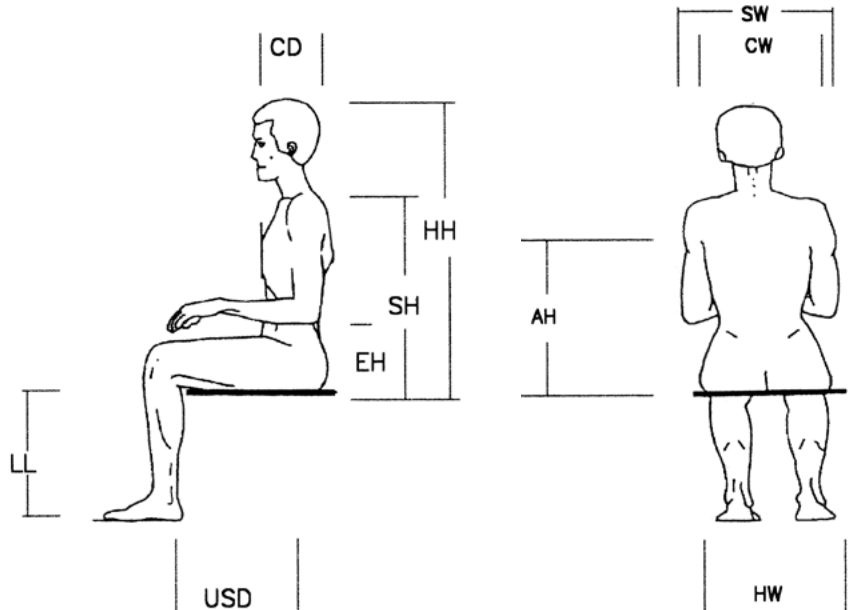

Solid Seat Modifications [E2609]

Note: Please include Base Material Thickness in all thickness measurements. Standard Seat Thickness @ Rear is 2" overall (1 1/2" Foam).

Seat Construction (Must Choose One): Full Width Between Seat Rails Between Seat Rails/Full Width Foam **470C49=**

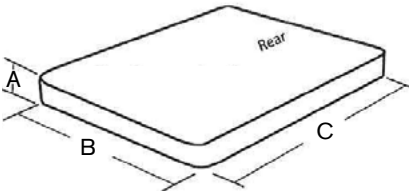
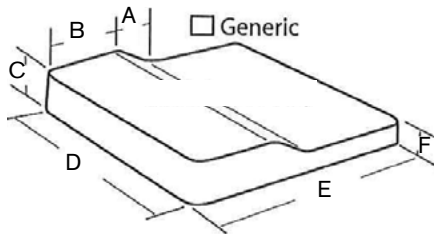
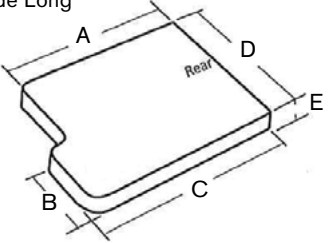
<p>Rectangular Seat</p>  <p>A _____ B _____ C _____</p>	<p>Anti-Thrust Seat ATSM \$300</p>  <p>A _____ D _____ B _____ E _____ C _____ F _____</p>	<p>Asymmetrical Seat Depth ASD \$124</p> <p>Left Side Long</p>  <p>A _____ D _____ B _____ E _____ C _____</p>
---	---	---

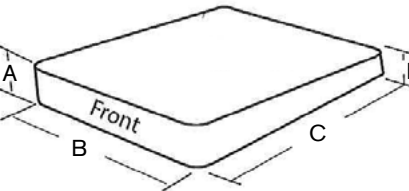
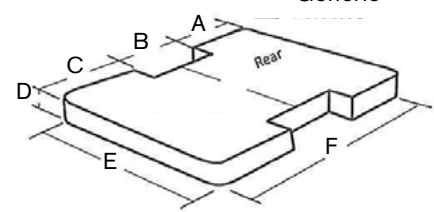
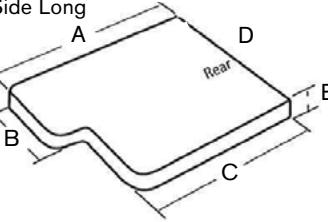
<p>Wedge Seat WSF \$102</p>  <p>A _____ D _____ B _____ C _____</p>	<p>I Seat ASM \$170</p> <p>Generic</p>  <p>A _____ D _____ B _____ E _____ C _____ F _____</p>	<p>Asymmetrical Seat Depth ASD \$124</p> <p>Right Side Long</p>  <p>A _____ D _____ B _____ E _____ C _____</p>
---	---	---

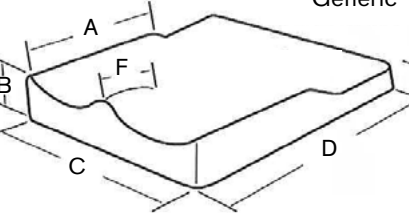
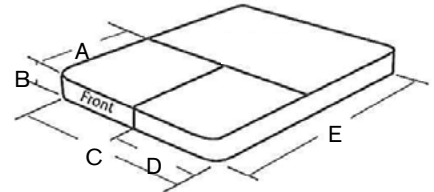
<p>Contoured Seat CSM \$340</p> <p>Generic</p>  <p>A _____ D _____ B _____ E _____ C _____ F _____</p>	<p>Split Seat LSS \$460</p>  <p>A _____ D _____ B _____ E _____ C _____</p>	<p>Custom Drawing</p> <p>A _____ D _____ B _____ E _____ C _____ F _____</p>
--	---	--

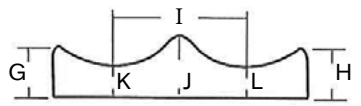

G _____ J _____
H _____ K _____
I _____ L _____

Additional Seat Modifications		
470C49=AATSM	Adj. Depth Anti-Thrust (fill in Anti-Thrust "B" _____ " to _____ ")	\$440
470C49=AATCSM	Adj. Depth Contoured Anti-Thrust (fill in Anti-Thrust "B" _____ " to _____ ")	\$460
470C49=BIMTS	Built in Medial Thigh Support	\$290
470C49=BILS	Built in Lateral Supports	\$290
470C49=WFSM	Waterfall Front Seat	\$ 84
470C49=GSM	Grid Seat	\$540
470C49=POM	Pelvic Obliquity	\$210
470C49=NOTCH	Notch for Back Posts	No Charge
470C49=SBC	Separate Base and Cushion	\$ 50

Solid Back Measurement Modifications [E2617]

Note: Please include Base Material Thickness in all thickness measurements. Standard Back Thickness is 1 1/2" overall (1" Foam) (unless specified).

Back Construction (Must Choose One): Full Width Between Back Posts Between Back Posts/Full Width Foam

470C49=

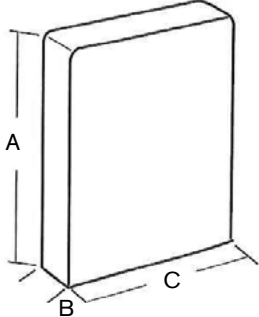
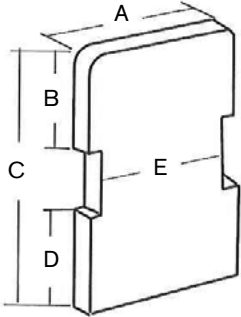
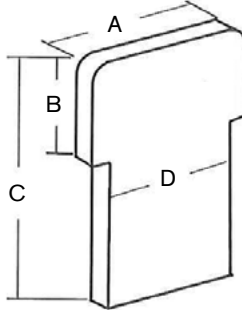
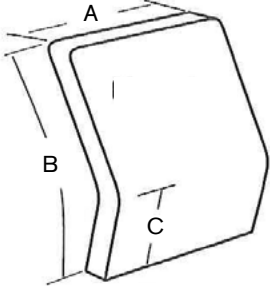
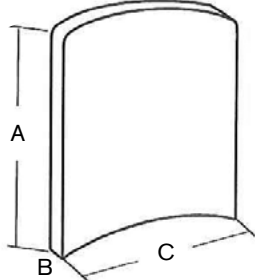
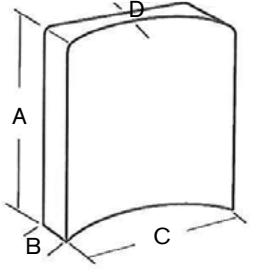
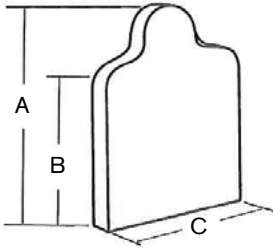
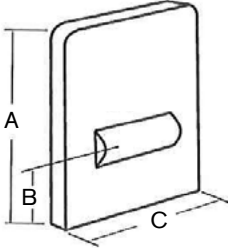
<p>Rectangular Back</p>  <p>A _____ B _____ C _____</p>	<p>I—Back IBM \$170</p>  <p>A _____ D _____ B _____ E _____ C _____ Generic</p>	<p>T—Back TBM \$170</p>  <p>A _____ D _____ B _____ Generic C _____</p>
<p>Biangular Back BBM \$420</p>  <p>A _____ C _____ B _____ Rotational RBBM \$560</p>	<p>Curved Back (wood) CURVE \$ 170</p>  <p>A _____ C _____ B _____</p>	<p>Curved by Foam CBF \$170</p>  <p>A _____ C _____ B _____ D _____ Generic</p>
<p>Scapular Cut Outs SCRCO \$160</p>  <p>A _____ B _____ C _____</p>	<p>Lumbar Support LRF \$ 170</p>  <p>A _____ W/ Hardware B _____ C _____ LRH \$380</p>	<p>Custom Drawing</p> <p>A _____ D _____ B _____ E _____ C _____ F _____</p>

Additional Back Modifications

470C49=COBM	Contoured Back	\$340
470C49=LCBM	Lateral Control Back	\$560
470C49=GBM	Grid Back	\$540
470C49=WBF	Wedge Cut Back Foam	\$102
470C49=SPRCO	Spinal Relief Cut Out	\$95
470C49=SRGI	Spinal Relief Gel Insert	\$260
470C49=DERF	Dynamic Extension Relief	\$460
470C49=IDERF	Independent Dynamic Extension Relief	\$389

Finishing Options -SEAT				
470C49=SOL	E2609	Incontinence Liners - Spray-on (Air permeable)		\$ 100
470C49=BIC	E2609	Incontinence Liners - Sew on (zippered)		\$ 144
470C49=RSC	E2609	Covers- Removable, secondary (top of cover is replaceable)		\$130
470C49=ECM	E2609	Covers- Extra Cover Modification (Complete cover - requires hardware removal for replacement)		\$144
470C49=AFCM	E2609	Covers- 3 Dimensional Spacer Fabric		\$ 90
470C49=HDC	E2609	Heavy Duty Construction (3/4" base, extra mounting hardware as needed)		\$ 160
Foams - Standard Foam is 1 1/2" High Density in Seat (#'s from foam samples)				
470C49=SF5M	E2609	Sunmate, per inch	Soft (#4) Medium (#5)	\$120
470C49=SF7F	E2609	T-Foam, per inch	Extra Soft (#10) Soft (#11) Medium (#12) Firm (#13)	\$120
470C49=PF1	E2609	Pudgee, per inch (#6)		\$ 320
470C49=PF2	E2609	Pudgee, 2 inch (#7)		\$420
470C49=GELS	E2609	Action Gel Insert (#14)		\$ 280
470C49=FIPS	E2609	Foam in Place (1 unit SSM)		\$ 820
470C49=ASF	E2609	Additional Standard Foam per 1/2" (#2)		\$ 22

Custom Seat Foam - Please indicate foam type by #'s from Foam Samples. Specify foam thickness for each layer.	(Top)
	(Middle)
	(Bottom)
	1/2" Wood

Finishing Options -BACK				
470C49=SOL	E2617	Incontinence Liners - Spray-on (Air permeable)		\$ 100
470C49=BIC	E2617	Incontinence Liners - Sew on (zippered)		\$ 144
470C49=RSC	E2617	Covers- Removable, secondary (top of cover is replaceable)		\$ 130
470C49=ECM	E2617	Covers- Extra Cover Modification (Complete cover - requires hardware removal for replacement)		\$ 144
470C49=AFCM	E2617	Covers- 3 Dimensional Spacer Fabric		\$ 94
470C49=HDC	E2617	Heavy Duty Construction (3/4" base, extra mounting hardware as needed)		\$ 160
Foams - Standard Foam is 1" High Density in Backrest (#'s from foam samples)				
470C49=SF5M	E2617	Sunmate, per inch	Soft (#4) Medium (#5)	\$ 120
470C49=SF7F	E2617	T-Foam, per inch	Extra Soft (#10) Soft (#11) Medium (#12) Firm (#13)	\$ 120
470C49=PF1	E2617	Pudgee, per inch (#6)		\$ 320
470C49=PF2	E2617	Pudgee, 2 inch (#7)		\$420
470C49=GELS	E2617	Action Gel Insert (#14)		\$ 320
470C49=FIPBLP	E2617	Foam in Place Back - Low Profile (1 unit SSM)		\$ 570
470C49=ASF	E2617	Additional Standard Foam per 1/2" (#2)		\$ 22

CustomBack Foam - Please indicate foam type by #'s from Foam Samples. Specify foam thickness for each layer.	(Top)
	(Middle)
	(Bottom)
	1/2" Wood

Transit Hardware Option - Knob Release Hardware Only - Add \$ 176 per Pair

Seating Packages (Includes hinged seat and/or back with all mounting hardware)				
470C49=SS100	E2609 + E2617	Seat/Back with Knob Hardware - 14" and smaller		\$ 1688
470C49=SS100-S	E2609	Seat with Knob Hardware - 14" and smaller		\$ 844
470C49=SS100-B	E2617	Back with Knob Hardware - 14" and smaller		\$ 844
470C49=SS101	E2609 + E2617	Seat/Back with Knob Hardware - 15" and Larger		\$ 1740
470C49=SS101-S	E2609	Seat with Knob Hardware - 15" and Larger		\$ 860
470C49=SS101-B	E2617	Back with Knob Hardware - 15" and Larger		\$ 860
470C49=SS103	E2609 + E2617	Seat/Back with Adjustable Drop Hook Hardware - 14" and smaller		\$ 1280
470C49=SS104	E2609 + E2617	Seat/Back with Adjustable Drop Hook Hardware - 15" and Larger		\$ 1396
470C49=SS105	E2609 + E2617	Back with Knob Hardware and Velcro Seat - 14" and smaller		\$ 1230
470C49=SS106	E2609 + E2617	Back with Knob Hardware and Velcro Seat - 15" and Larger		\$ 1520
470C49=SS107	E2609 + E2617	Mini Seat/Back with Mini Knob Hardware 10"-12" wide		\$ 1640
470C49=SS107-S	E2609	Mini Seat with Mini Knob Hardware 10"-12" wide		\$ 820
470C49=SS107-B	E2617	Mini Back with Mini Knob Hardware 10"-12" wide		\$ 820
470C49=SS108	E2609 + E2617	Planar Seat and Back 1" clips		\$ 1030
Solid Seats with Hardware (4 point attachment)				
470C49=SFH100	E2609	Solid Seat with Flush Mount Drop Hooks		\$ 580
470C49=SFH101	E2609	Solid Seat with 1" Drop Hooks		\$ 580
470C49=SFH102	E2609	Solid Seat with 2" Drop Hooks		\$ 580
470C49=SAH100	E2609	Solid Seat with Adjustable Drop Hooks		\$ 650
470C49=SKR100	E2609	Solid Seat with Knob Release Hardware - 2 pair		\$ 940
470C49=VL2	E2609	AEL Versa Lock Clips in Lieu of Horseshoe Clips - 1 pair		\$ 98
470C49=VL4	E2609	AEL Versa Lock Clips in Lieu of Horseshoe Clips - 2 pair		\$ 196
Solid Seats without Hardware				
470C49=SSI100	E2609	Solid Seat Insert (comes standard with hook and loop)		\$ 248
470C49=SSI101	E2609	Solid Seat Insert with T-Nuts		\$ 330
Drop Bases				
470C49=DBF100		Plastic Base with Flush Mount Drop Hooks		\$ 400
470C49=DBF101		Plastic Base with 1" Drop Hooks		\$ 400
470C49=DBF102		Plastic Base with 2" Drop Hooks		\$ 400
470C49=DBA100		Plastic Base with Adjustable Drop Hooks		\$ 420
Solid Backs with Hardware (4 point attachment)				
470C49=BFH100	E2617	Solid Back with Flush Mount Drop Hooks		\$ 580
470C49=BFH101	E2617	Solid Back with 1" Drop Hooks		\$ 580
470C49=BFH102	E2617	Solid Back with 2" Drop Hooks		\$ 580
470C49=BAH100	E2617	Solid Back with Adjustable Drop Hooks		\$ 650
470C49=BKR100	E2617	Solid Back with Knob Release Hardware - 2 pair		\$ 940
470C49=VL2	E2617	AEL Versa Lock Clips in Lieu of Horseshoe Clips - 1 pair		\$ 98
470C49=VL4	E2617	AEL Versa Lock Clips in Lieu of Horseshoe Clips - 2 pair		\$ 196
Solid Backs without Hardware				
470C49=SBI100	E2617	Solid Back Insert (comes standard with hook and loop)		\$ 280
470C49=SBI101	E2617	Solid Back Insert with T-Nuts		\$ 380
Seat to Back Bracket				
471C49=STBHF		Flush Hinge		\$142
471C49=STBH15		1 1/2" Offset Hinge		\$142
471C49=STBH30		3" Offset Hinge		\$142

Thoracic and Lateral Support

Lateral Hip/Thigh Supports [E0956 + E1028] 471C49=

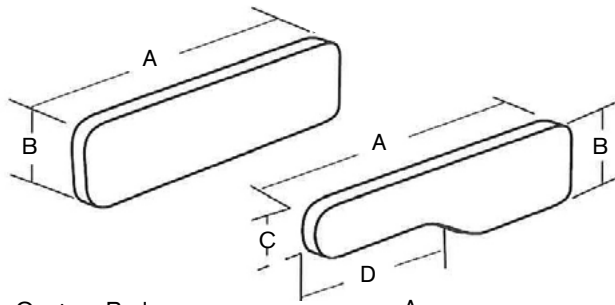

Custom Pad _____ A _____
 Thickness _____ B _____
Note: Standard Pad Thickness is 1." C _____
 D _____

Hardware

Fixed Bracket LHS-F \$ 380
 Quick Release Bracket LHS-QR \$ 700
 Offset Inch 1" 2"

Medial Thigh Support (Hip Abductor) 471C49=
 [E0957 + E1028]

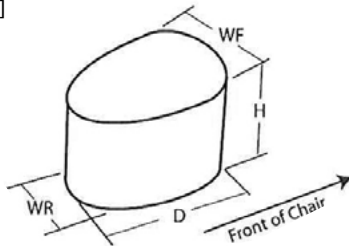

WF x WR x D x H
 Small 3 x 1 1/2 x 3 1/2 x 3
 Medium 3 1/2 x 2 1/2 x 4 x 3 1/2
 Large 4 x 3 x 4 1/2 x 4
 Custom _____ x _____ x _____ x _____

Hardware

Flip Down Bracket ABD-FD \$ 590
 Slide Out Bracket ABD-SO \$ 394
 Drop In Bracket ABD-DI \$ 590
 Quick Release Flip Under ABD-FQR \$ 620

Lateral Knee Supports 471C49=

Lateral Knee Supports [E0956 + E1028] \$266
 (Clamp on to footrest hanger)

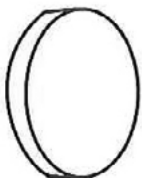

Pad Size
 3" Round
 4" Round
 Custom _____ x _____

Tubing Diameter 7/8" NT-LKS78
 1" NT-LKS88

Bracket Height Short Tall

Lateral Thoracic Supports [E0956 + E1028] 471C49=

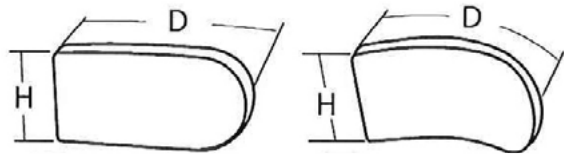

Flat Pad Curved Pad

H D
 Small 3 x 4
 Medium 4 x 5
 Large 5 x 6
 Custom _____ x _____

Custom Pad Thickness _____
Note: Standard Pad Thickness is approximately 3/4"

Hardware

Fixed Brackets LTS-F \$ 380
 Summer Winter Brackets LTS-SW \$ 672
 Push Button Swingaway Brackets LTS-PB \$ 738
 Summer Winter Swingaway Brkts. LTS-SWPB
 Lift to Release Swingaway Brkts LTS-SA \$ 600
 Offset Inch 1" 2"

Tracks [K0108] 470C49=

11" Double NT-TRK-11D \$ 116
 11" Single NT-TRK-11S \$ 116
 13" Double NT-TRK-13D \$ 118
 15" Double NT-TRK-15D \$ 118
 3" Double NT-TRK-3D \$ 108
 3" Single NT-TRK-3S \$ 104
 5" Double NT-TRK-5D \$ 110
 5" Single NT-TRK-5S \$ 110
 7" Double NT-TRK-7D \$ 112
 7" Single NT-TRK-7S \$ 112
 9" Double NT-TRK-9D \$ 114
 9" Single NT-TRK-9S \$ 114

Arm Rest (Hip Support Mount) 411C49=

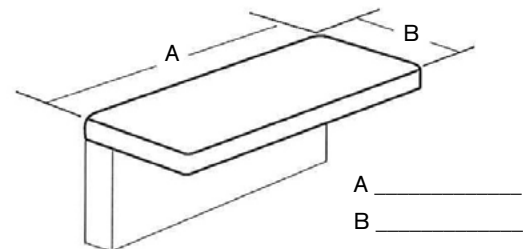

Fixed Height AR-FH \$372
 Adjustable Height AR-AH \$606

Headrest Support [E0955 + E1028]

471C49=



Multi-Axis Offset
HR-MABRKT \$ 326



Rock-n-Lock
HR-RNLBRKT-4 \$ 440
RLBRKT-MA-4 \$ 516
(Multi-Axis Mod.)
DRLBRKT-4M \$ 656
(Dynamic Mod.)



L-Bracket
HR-LBRKT \$ 130



Flip Down Rock-n-Lock
HR-FDBRKT-4 \$ 450



Depth Adjustable
HR-DABRKT \$ 320



Concave
HR-CPAD \$220
Size S M L



Lateral Control
HR-LCPAD \$282
Size S M L



3-Pad
Fixed
HR-3PPAD \$306
Hinged
HR-3PHPAD \$385
Size S M L



Komfi Fit
HR-KFPAD
\$247 One
Size Only



Adjustable Concave
HR-ACPAD \$333
Size M L



Belled
HR-BLPAD
\$320 One
Size Only

Foot Supports [K0108] 471C49=

Footboxes

Mounting Options

Bolt to Footplate

Bolt to Solid Seat (fixed angle)

Other _____

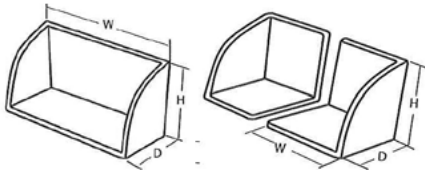

Double Leg Footbox \$571

	W	D	H
Small FB-DLS	11	8	7
Medium FB-DLM	13	10	9
Large FB-DLL	15	12	11
Custom FB-DLC	___	___	___

Single Leg Footbox \$664

	W	D	H
Small FB-SLS	5	8	7
Medium FB-SLM	6	10	9
Large FB-SLL	7	12	11
Custom FB-SLC	___	___	___

Foot Supports with Padded Straps \$253

Small	FSS
Medium	FSM
Large	FSL
Extra Large	FSXL

Ankle Holders \$155

Small	AH-S
Medium	AH-M
Large	AH-L
Extra Large	AH-XL

Pelvic Positioning Belts [E0978] 471C49=

Hip Belt Padded

Miniature 1"	PB-PHB-M	\$50
Pediatric 1½" x 44"	PB-PHB-P	\$50
Adult 2" x 48"	PB-PHB-A	\$62

Center Pull - 2 Point Padded \$120

Extra Small	PB-PHBXS-CP
Small	PB-PHBS-CP
Medium	PB-PHBM-CP
Large	PB-PHBL-CP
Extra Large	PB-PHBXL-CP

Center Pull - 4 Point Padded \$ 146

Extra Small	PB-4PXS-CP
Small	PB-4PS-CP
Medium	PB-4PM-CP
Large	PB-4PL-CP

Double Rear Pull - 2 Point Padded \$130

Extra Small	PB-PHBXS-DP
Small	PB-PHBS-DP
Medium	PB-PHBM-DP
Large	PB-PHBL-DP
Extra Large	PB-PHBXL-DP

Double Rear Pull-4 Point Padded \$166

Small	PB-4PS-DP
Medium	PB-4PM-DP
Large	PB-4PL-DP

Chest Belts [E0960] 471C49=

Static H-Belt

Small	PB-HBS	\$166
Medium	PB-HBM	
Large	PB-HBL	

Dynamic H-Belt

Small	PB-DHBS	\$204
Medium	PB-DHBM	
Large	PB-DHBL	

Static Back Pack Straps \$142

Small	PB-BPSS
Medium	PB-BPSM
Large	PB-BPSL

Dynamic Back Pack Straps \$174

Small	PB-DBPSS
Medium	PB-DBPSM
Large	PB-DBPSL

Static Butterfly Chest Belt \$182

Extra Small	PB-BFXS
Small	PB-BFS
Medium	PB-BFM
Large	PB-BFL

Dynamic Butterfly Chest Belt \$214

Extra Small	PB-DBFXS
Small	PB-DBFS
Medium	PB-DBFM
Large	PB-DBFL

Strap Risers [K0108]

1" w/Fastners	SR-1	\$80
2" w/Fastners	SR-2	\$92

Wheelchair Trays (must fill in tray measurement form below)			
471C49=NT4000	E0950	NUTEC Wheelchair Tray Please specify tray material: 1/4" Clear Acrylic 1/4" ABS 3/8" Wood 3/8" Polycarbonate	\$190
471C49=NT4002	E0950	Full Padded Tray - 1/2' Wood & 1" Foam	\$360
471C49=TM-RIM	E0950	Add 1/2" PVC Rim to Tray	\$66

Tray Hardware			
471C49=TM-SR	K0108	Standard Tray Rails	\$108
471C49=TM-TR	K0108	Tubular Tray Rails	\$108
471C49=TM-CLR	K0108	Cam Lock Tray Rails	\$160
471C49=TM-TC	K0108	Tray Clamps - Toggle	\$165
471C49=TM-TTCK	K0108	Toggle Clamp Kit w/ Width Adjustable Support Rail	\$290
471C49=TRAYTRKS	K0108	Tray Tracks - For Mounting Tray Rails	\$160

Tray Accessories			
471C49=TM-RS	K0108	Tray Retaining Strap	\$28
471C49=TM-SPP	K0108	Shoulder Protection Pads - Tray Mount	\$240
471C49=TM-EP	K0108	Elbow Pads - Tray Mount - Velcro On	\$94
471C49=TM-FP	K0108	Tray Pad- Full Size - Velcro On	\$150
471C49=TM-HP	K0108	Tray Pad- Half Size - Velcro On	\$140
471C49=TM-PDCO	K0108	Powerdrive Cut Out (indicate location on tray measurement form below)	\$42

Tray Measurement Form

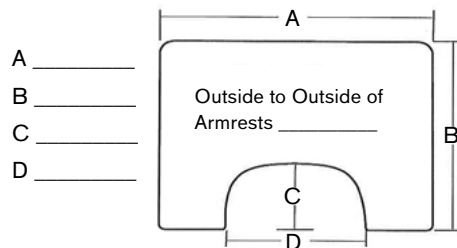

Miscellaneous Items			
471C49=NT-O2H	K0108	Oxygen Tank Holder- Frame Mount w/ Clamps for E Cylinder	\$454
470C49=NT-COVM-TR	K0108	LTV Ventilator Mount - Clamp on (Please Specify 7/8 or 1" tubing)	\$585
470C49=NT-COVM-DT	K0108	LTV Ventilator Mount -Clamp On - Trilogy -(Please Specify 7/8" or 1"tubing)	\$585
471C49=NT-IVP48	K0108	IV Pole Clamp on 48"	\$472

Amputee Support			
471C49=BKS-100	E1020	Amputee Support - Multiarticular (fits 7/8 or 1" tubing)	\$400
471C49=BKS101	E1020	Amputee Support - Bent Tube (fits 7/8 or 1" tubing)	\$380
471C49=BKS-STRAP	K0108	Positioning Strap for Amputee Support	\$40